

Article number: 20475B15B12MT

Description: E+G Two-way clamp mounting - GN 475-B15-B12-MT

Measures

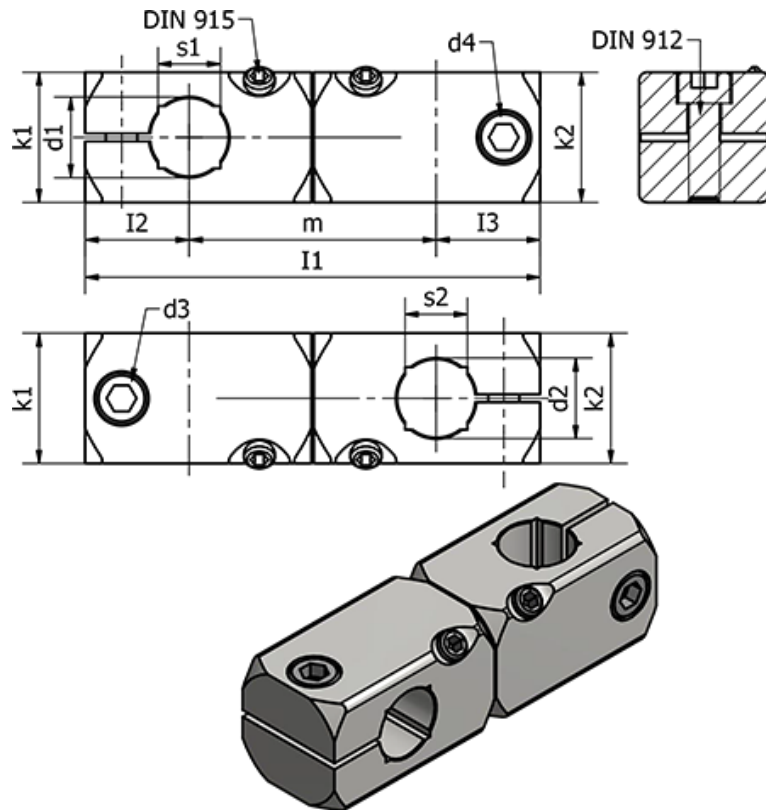

Clamping kit for d3 = GN 511-M6-25

Clamping kit for d4 = GN 511-M5-20

d1 = 15

d2 = 12

d3 = M6

d4 = M5

I1 = 79.5

I2 = 20

I3 = 16.5

k = 25

k2 = 20

m = 43

s1 = 12

s2 = 10

Weight (g) = 109